

剖面 C-C

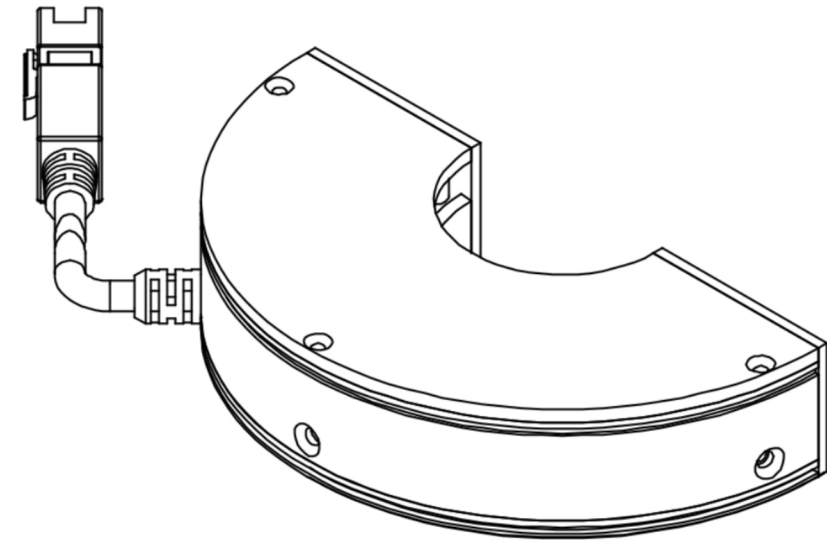

Details of Connector

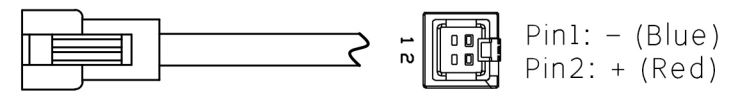

Connector Type: SMR-03V-B (Light Side)
SMP-03V-BC (Power Supply Side)

Specification:

MODEL	PL-RIC9000-W/-B/-G/-UV	-R/-IR850/-IR940
Wavelength (nm)	6500K/470/530/385	625/850/940
Power Supply	DC24V/5.8 (W)	DC24V/3.1 (W)

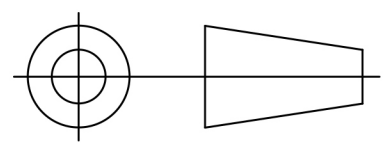

Itemref	Quantity	Material: AL/ACRIL	ArticleNo./Reference
			Filename PL-RIC9000
			Scale 1/1
PL-RIC9000-U			
PL-RIC9000-0000		Edition VER.1.0	Sheet 1