

剖面 G-G

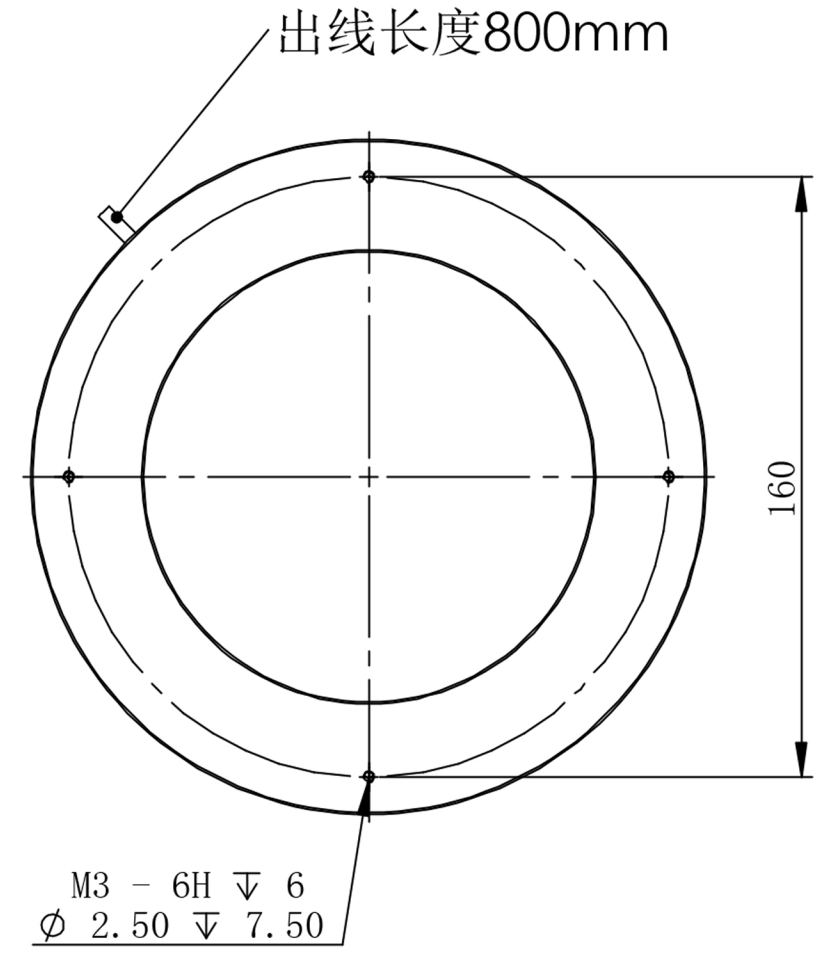

Details of Connector

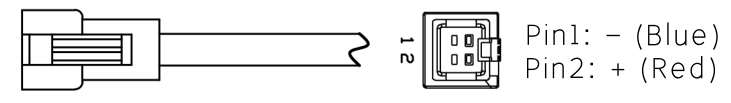

Connector Type: SMR-03V-B (Light Side)
SMP-03V-BC (Power Supply Side)

Specification:

MODEL	PL-RI18045-W/-B/-G/-UV	-R/-IR850/-IR940
Wavelength (nm)	6500K/470/530/385	625/850/940
Power Supply	DC24V/28.6 (W)	DC24V/19 (W)

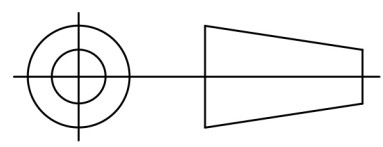

Itemref	Quantity	Material: AL/ACRIL	ArticleNo./Reference
			Filename PL-RI18045
		Scale 1/1	
			PL-RI18045-U
		PL-RI18045-0000	Edition VER.1.0
			Sheet 1