

A
B
C
D
E
F

A
B
C
D
E
F

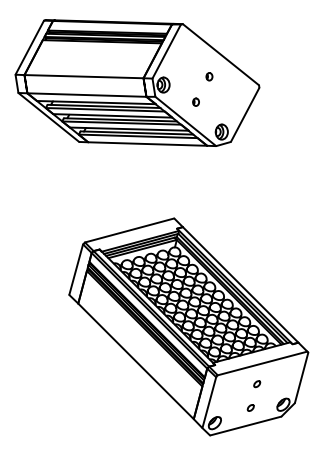

Details of Connector

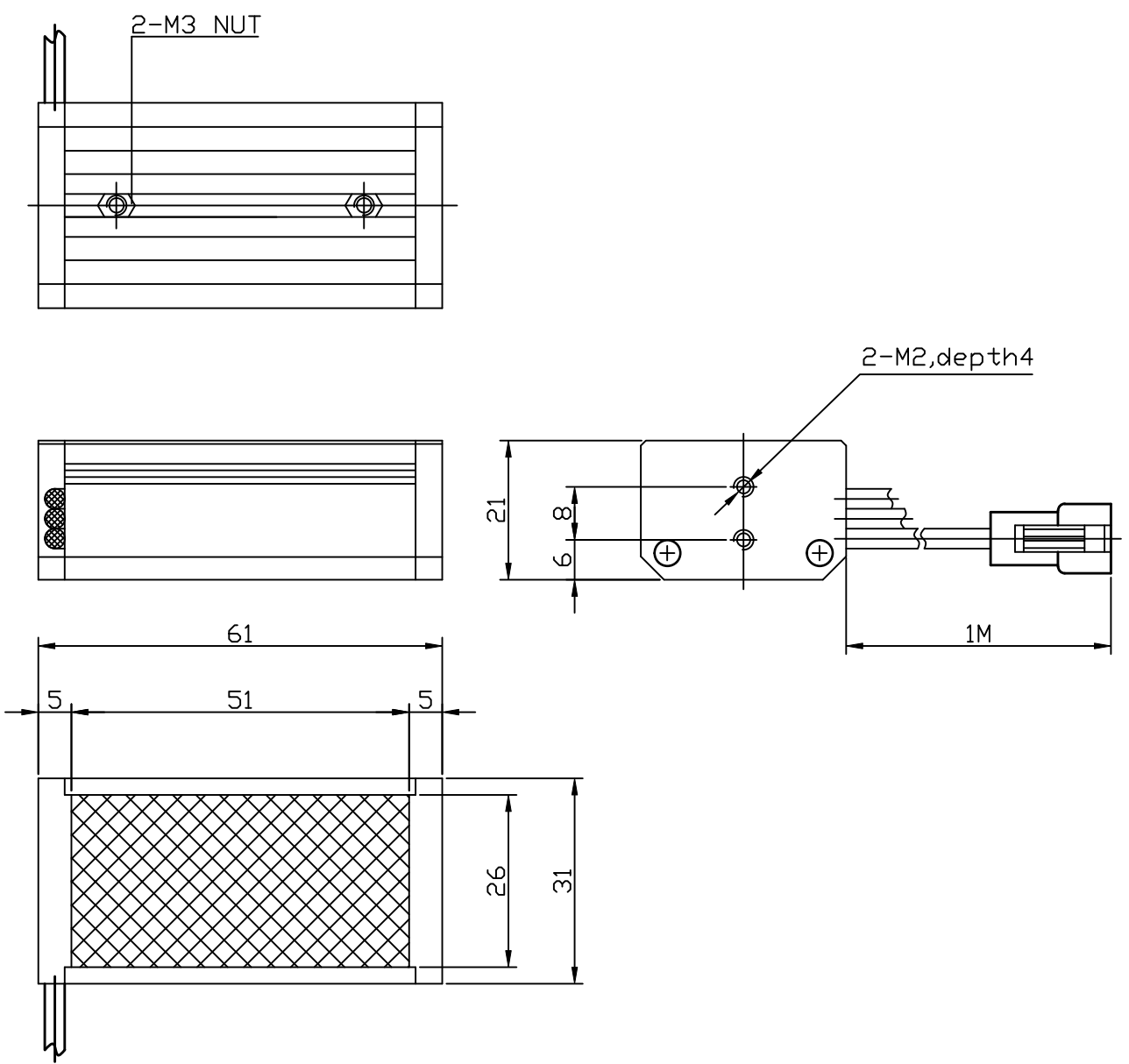
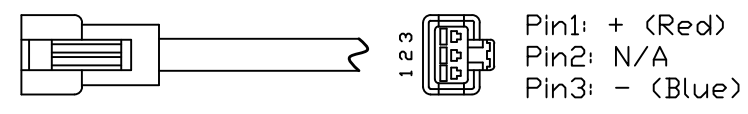

Connector Type: SMR-03V-B (Light Side)
SMP-03V-BC (Power Supply Side)

Specification:

MODEL	WRGBDL-50L26
Wavelength(nm)	625/525/470
Power Supply	DC24V/2.9(W)
Weight	50g

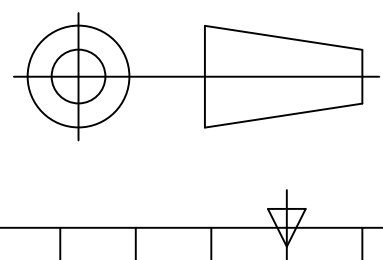

Itemref	Quantity	Material: AL	Article No./Reference		
DESIGNED_BY	CHECKED_BY	Approved by - date 2014-09-10	Filename WRGBDL-50L26	Date 2014-09-10	Scale 1/1
WAVECREST(SH)			WRGBDL-50L26-USER		
			WRGBDL-50L26-0000	Edition VER.1.0	Sheet 1