

A
B
C
D
E
F

A
B
C
D
E
F

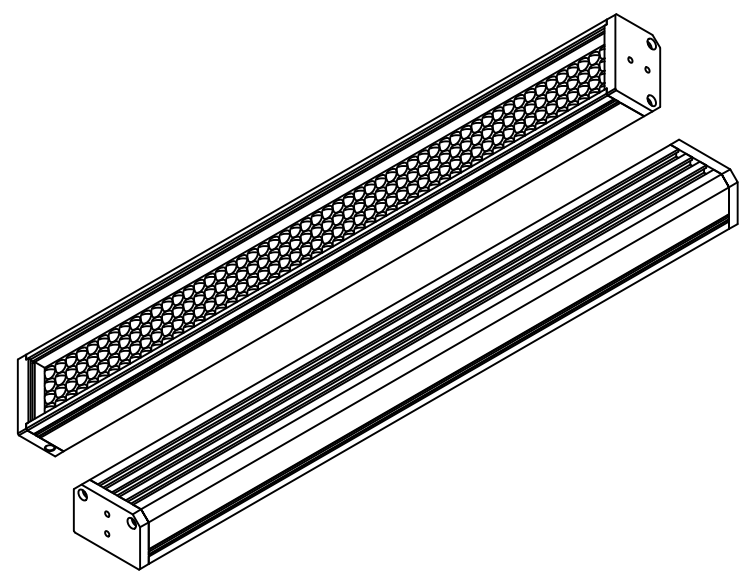

Details of Connector

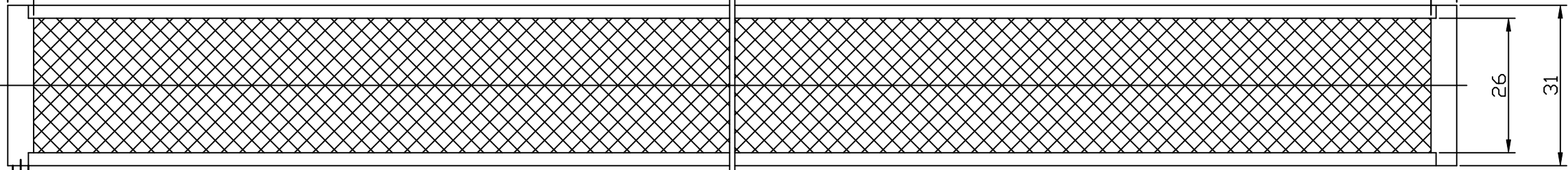
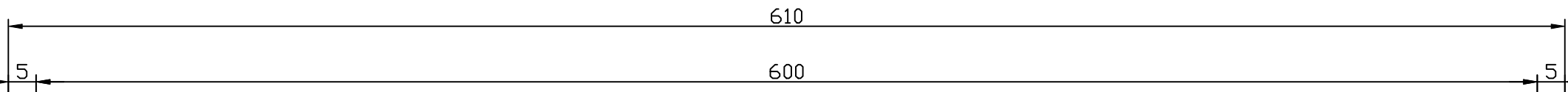
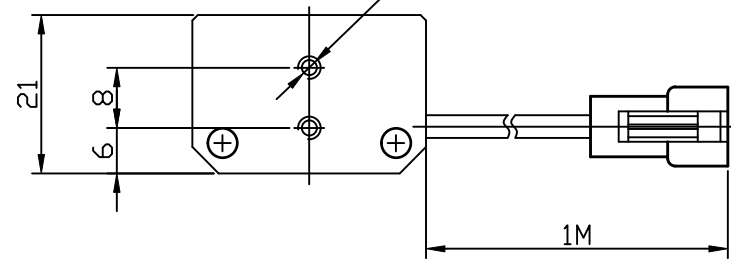
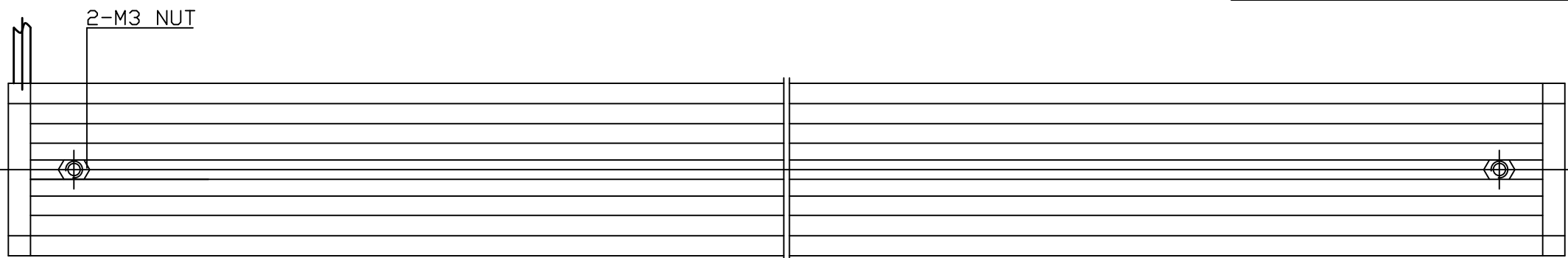
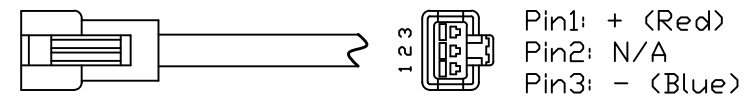

Connector Type: SMR-03V-B (Light Side)
SMP-03V-BC (Power Supply Side)

Specification:

MODEL	WLDL-600L26-W/-B/-G/-UV	-Y/-R/-IR850/-IR940
Wavelength(nm)	6500K/470/525/390	590/625/850/940
Power Supply	DC24V/43.2(W)	DC24V/28.8(W)
Weight	432g	

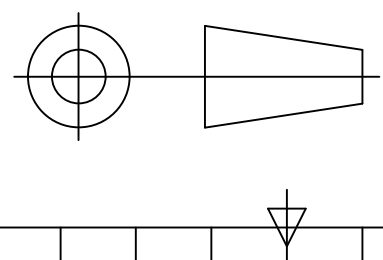

Itemref	Quantity	Material: AL	Article No./Reference		
Designed by Y.KOTANI	Checked by T.ONO	Approved by - date JULY-20,2014	Filename WLDL-600L26	Date JULY-20,2014	Scale 1/1
WAVECREST(SH)			WLDL-600L26-USER		
			WLDL-600L26-0000	Edition VER.1.0	Sheet 1